

# P-300 Rhythm Detection Using ANFIS Algorithm and Wavelet Feature Extraction in EEG Signals

Juan Manuel Ramírez-Cortes, Vicente Alarcon-Aquino, Gerardo Rosas-Cholula, Pilar Gomez-Gil,  
Jorge Escamilla-Ambrosio

**Abstract**— P300 evoked potential is an electroencephalographic (EEG) signal obtained at the central-parietal region of the brain in response to rare or unexpected events. In this work, an experiment on the detection of a P-300 rhythm for potential applications on brain computer interfaces (BCI) using an Adaptive Neuro Fuzzy algorithm (ANFIS) is presented. The P300 evoked potential is obtained from visual stimuli followed by a motor response from the subject. The EEG signals are obtained with a 14 electrodes Emotiv EPOC headset. Preprocessing of the signals includes denoising and blind source separation using an Independent Component Analysis algorithm. The P300 rhythm is detected using the discrete wavelet transform (DWT) applied on the preprocessed signal as a feature extractor, and further entered to the ANFIS system. Experimental results are presented.

**Index Terms**—ANFIS, brain computer interface, P-300 signal, wavelet.

## I. INTRODUCTION

Brain Computer Interfaces (BCIs) are systems which allow people to control computer applications using their brain signals. In the last years, there has been a growing interest in the research community on signal processing techniques oriented to solve the multiple challenges involved in BCI applications [1-3]. An important motivation to develop BCI systems, among some others, would be to allow an individual with motor disabilities to have control over specialized devices such as computers, speech synthesizers, assistive appliances or neural prostheses. A dramatic relevance arises when thinking about patients with severe motor disabilities such as locked-in syndrome, which can be caused by amyotrophic lateral sclerosis, high-level spinal cord injury or

brain stem stroke. In its most severe form people are not able to move any limb. BCIs would increase an individual's independence, leading to an improved quality of life and reduced social costs. Among the possible brain monitoring methods for BCI purposes, the EEG constitutes a suitable alternative because of its good time resolution, relative simplicity and noninvasiveness when compared to other methods such as functional magnetic resonance imaging, positron emission tomography (PET), magnetoencephalography or electrocorticogram systems.

There are several signals which can be extracted from the EEG in order to develop BCI systems, including the slow cortical potential [4],  $\mu$  and  $\beta$  rhythms [5,6], motor imagery [7], static-state visually evoked potentials [8,9], or P300 evoked potentials [10-12]. P300 evoked potentials occur with latency around 300 milliseconds in response to target stimuli that occur unexpectedly. In a P300 controlled experiment, subjects are usually instructed to respond in a specific way to some stimuli, which can be auditory, visual, or somatosensory. P300 signals come from the central-parietal region of the brain and can be found more or less throughout the EEG on a number of channels. The P300 is an important signature of cognitive processes such as attention and working memory and an important clue in the field of neurology to study mental disorders and other psychological disfunctionalities [13].

In this work, an experiment on P-300 rhythm detection using wavelet-based feature extraction, and an ANFIS algorithm is presented. The experiment has been designed in such a way that the P300 signals are generated when the subject is exposed to some visual stimuli, consisting of a sequential group of slides with a landscape background. Images of a ship are inserted using a controlled non-uniform sequence, and the subject is asked to press a button when the ship unexpectedly appears. The EEG signals are preprocessed using an Independent Component Analysis (ICA) algorithm, and the P300 is located in a time-frequency plane using the Discrete Wavelet Transform (DWT) with a sub-band coding scheme. The rest of the paper is organized as follows: Section 2 presents the theory associated to the wavelet sub-band coding algorithm. Section 3 describes Independent Component Analysis (ICA) as part of the pre-processing stage. Section 4 reports the evoked potential experiment and the proposed method on P300 signal detection. Section 5 describes the ANFIS model and its application to the EEG signals. Section 6 presents obtained results, and section 7 presents some concluding remarks, perspectives, and future direction of this research oriented to the implementation of a BCI system.

Manuscript received July 15, 2010. This work was supported in part by the Mexican National Council for Science and Technology (CONACYT) and the Puebla State government grant number 109417.

J.M. Ramirez-Cortes is with the Electronics Department, National Institute of Astrophysics, Optics, and Electronics, Tonantzintla, Puebla, 72000, Mexico (phone/fax: 52-222-247-0517; (e-mail: jmram@inaoep.mx).

V. Alarcon-Aquino is with the Electrical and Computing Engineering Department, Universidad de las Americas, Puebla, 72000, Mexico (e-mail: vicente.alarcon@udlap.mx).

G. Rosas-Cholula is with the Electronics Department, National Institute of Astrophysics, Optics, and Electronics, Tonantzintla, Puebla, 72000, Mexico (e-mail: grosas@inaoep.mx).

P. Gomez-Gil is with the Computer Department, National Institute of Astrophysics, Optics, and Electronics, Tonantzintla, Puebla, 72000, Mexico (e-mail: pgomez@inaoep.mx).

J. Escamilla-Ambrosio is with the Electronics Department, National Institute of Astrophysics, Optics, and Electronics, Tonantzintla, Puebla, 72000, Mexico (e-mail: jescami@inaoep.mx).

II. DISCRETE WAVELET TRANSFORM (DWT)

The Discrete Wavelet Transform (DWT) is a transformation that can be used to analyze the temporal and spectral properties of non-stationary signals. The DWT is defined by the following equation [14]:

$$W(j, k) = \sum_j \sum_k f(x) 2^{-j/2} \psi(2^{-j} x - k) \quad (1)$$

The set of functions  $\psi_{j,k}(n)$  is referred to as the family of wavelets derived from  $\psi(n)$ , which is a time function with finite energy and fast decay called the mother wavelet. The basis of the wavelet space corresponds then, to the orthonormal functions obtained from the mother wavelet after scale and translation operations. The definition indicates the projection of the input signal into the wavelet space through the inner product, then, the function  $f(x)$  can be represented in the form:

$$f(x) = \sum_{j,k} d_j(k) \psi_{j,k} \quad (2)$$

where  $d_j(k)$  are the wavelet coefficients at level j. The coefficients at different levels can be obtained through the projection of the signal into the wavelets family as:

$$\langle f, \psi_{j,k} \rangle = \sum_l d_l \langle f, \phi_{j,k+l} \rangle \quad (3)$$

$$\langle f, \phi_{j,k} \rangle = \frac{1}{\sqrt{2}} \sum_l c_l \langle f, \phi_{j-1,2k+l} \rangle \quad (4)$$

The DWT analysis can be performed using a fast, pyramidal algorithm described in terms of multi-rate filter banks. The DWT can be viewed as a filter bank with octave spacing between filters. Each sub-band contains half the samples of the neighboring higher frequency sub-band. In the pyramidal algorithm the signal is analyzed at different frequency bands with different resolution by decomposing the signal into a coarse approximation and detail information. The coarse approximation is then further decomposed using the same wavelet decomposition step. This is achieved by successive high-pass and low-pass filtering of the time signal, and a down-sampling by two as defined by the following equations [15]:

$$a_j(k) = \sum_m \bar{h}(m-2k) a_{j+1}(m) \quad (5)$$

$$d_j(k) = \sum_m \bar{g}(m-2k) a_{j+1}(m) \quad (6)$$

Figure 1 shows a two-level filter bank. Signals  $a_j(k)$  and  $d_j(k)$  are known as approximation and detail coefficients, respectively. This process may be executed iteratively forming a wavelet decomposition tree up to any desired resolution level. In this work the analysis was carried out up to the 11 decomposition level (16 second windows with sampling frequency of 128 sps) applied on the signals separated from the ICA process described in the next section.

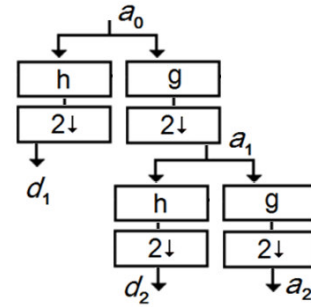

Fig. 1. Two-level wavelet filter bank in the sub-band coding algorithm

III. INDEPENDENT COMPONENT ANALYSIS (ICA) FOR THE PREPROCESSING OF THE EEG SIGNALS

Independent Component Analysis (ICA), an approach to the problem known as Blind Source Separation (BSS), is a widely used method for separation of mixed signals [16]. The signals  $x_i(t)$  are assumed to be the result of linear combinations of the independent sources, as expressed in equation 7.

$$x_i(t) = a_{i1}s_1(t) + a_{i2}s_2(t) + \dots + a_{in}s_n(t), \quad (7)$$

or in matrix form:

$$\mathbf{x} = \mathbf{A}\mathbf{s} \quad (8)$$

where  $A$  is a matrix containing mixing parameters and  $S$  the source signals. The goal of ICA is to calculate the original source signals from the mixture by estimating a de-mixing matrix  $U$  that gives:

$$\bar{\mathbf{s}} = \mathbf{U}\mathbf{x} \quad (9)$$

This method is called blind, because little information is available, i.e. both the mixing matrix  $A$  and the matrix containing the sources  $S$  are unknown. The de-mixing matrix  $U$  is found by optimizing a cost function. Several different cost functions can be used for performing ICA, e.g. kurtosis, negentropy, etc., therefore, different methods exist to estimate  $U$ . For that purpose the source signals are assumed to be non-gaussian and statistically independent. The requirement of non-gaussianity stems from the fact that ICA relies on higher order statistics to separate the variables, and higher order statistics of Gaussian signals are zero [17].

EEG consists of measurements of a set of  $N$  electric potential differences between pairs of scalp electrodes. Then the  $N$ -dimensional set of recorded signals can be viewed as one realization of a random vector process. ICA consists in looking for an overdetermined ( $N \times P$ ) mixing matrix  $A$  (where  $P$  is smaller than or equal to  $N$ ) and a  $P$ -dimensional source vector process whose components are the most statistically independent as possible. In the case of the P300 experiment described in this paper, ICA is applied with two objectives; denoising the EEG signal in order to enhance the signal to noise ratio of the P-300, and separating the evoked potential from some artifacts, like myoelectric signals derived from eye-blinking, breathing, or head motion.

IV. EXPERIMENTAL SETUP AND PROPOSED METHOD FOR P-300 SIGNAL DETECTION

In this work the EPOC headset, recently released by the Emotiv Company, has been used [18]. This headset consists of 14 data-collecting electrodes and 2 reference electrodes, located and labeled according to the international 10-20 system [19]. Following the international standard, the available locations are: AF3, F7, F3, FC5, T7, P7, O1, O2, P8, T8, FC6, F4, F8 and AF4. The EEG signals are transmitted wirelessly in the frequency of 2.4 GHz to a laptop computer.

This experiment consists of presenting a non-persistent image to cause a P300 response from the user. The block diagram of the system to evoke and capture P300 signals, and a picture of the described setup are shown in Figures 2 and 3, respectively. The subject is resting in a comfortably position during the testing. A simple graphical application shows in the screen a starship attacking a neighborhood in a fixed time sequence not known by the subject, as represented in Table I.

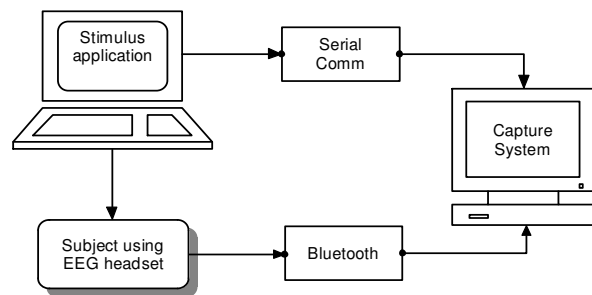

Fig. 2. Block diagram of the experimental setup used during the P300 signals detection



Fig. 3. Headset and stimulus used for the experiment on P300 signal detection.

Recognition of the ship by the subject, when it suddenly appears in the screen, is expected to generate a P300 evoked potential in the brain central zone. The serial port is used for sending time markers to the Emotive testbench, in synchrony with the moments when the ship appears in the screen. The Testbench application provided by Emotiv System Co., is used to capture raw data from the 14 electrodes, as shown in Figure 8. The operations proposed to detect the P300 rhythm are summarized in the block diagram of Figure 4. First, a

band-pass filter selects the required frequency components and cancels the DC value. Then, ICA blind source separation is applied with the purpose of denoising the EEG signal and separating the evoked potential from artifacts, like myoelectric signals derived from eye-blinking, breathing, or head motion, as well as cardiac signals.

Table I. Event time sequence examples.

Event	Time difference	Time(ms)
1	4000	4000
2	3000	7000
3	4000	11000
4	3000	14000
5	5500	19500
6	3000	22500
7	4000	26500
8	4500	31000

The P300 is further located in time and scale through a wavelet sub-band coding scheme. This information is further fed into an ANFIS system, as described in the next section.

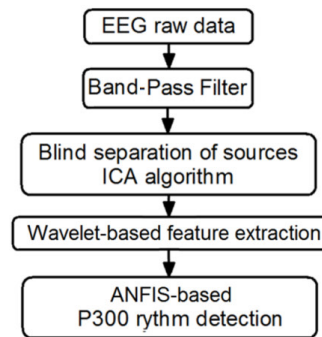

Fig. 4. Block diagram of the proposed system for ANFIS-based P-300 signal detection.

V. ADAPTIVE NEURO FUZZY INFERENCE SYSTEM AS CLASSIFIER

Adaptive Neuro Fuzzy Inference Systems (ANFIS) combine the learning capabilities of neural networks with the approximate reasoning of fuzzy inference algorithms. ANFIS uses a hybrid learning algorithm to identify the membership function parameters of Takagi-Sugeno type fuzzy inference systems. In this work, the ANFIS model included in the MATLAB toolbox has been used for experimentation purposes. A combination of least-squares and backpropagation gradient descent methods is used for training the FIS membership function parameters to model a given set of input/output data. ANFIS systems have been recently used for optimization, modeling, prediction, and signal detection, among others [20-23]. In this paper, the ANFIS system is proposed to be used for the detection of the P-300 rhythm in an EEG signal, for BCI applications. Frequency bands with the most significant energy content, in the range of the P-300 signal, are selected from the wavelet decomposition, as the input for the ANFIS system. These bands are 8-4, 4-2, 2-1, and 1-0.5 Hertz, which are considered as the linguistic variables B1, B2, B3 and B4, respectively. The ANFIS structure is depicted in Figure 5. Figure 6 shows the input Gaussian membership functions for input B1. The ANFIS is used to map the P300 signal composition to a triangle pulse

occurring simultaneously during the training stage. Figure 7 shows the ANFIS output following triangle pulses after a 400 epochs training. A trained ANFIS is further used during a verification stage, using the EEG signals obtained from 8 test subjects performing the same experiment with 10 trials of 16 seconds each.

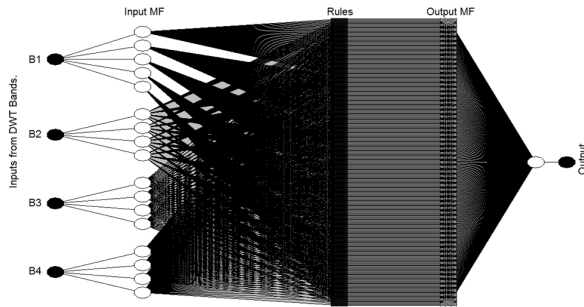

Fig. 5. ANFIS structure.

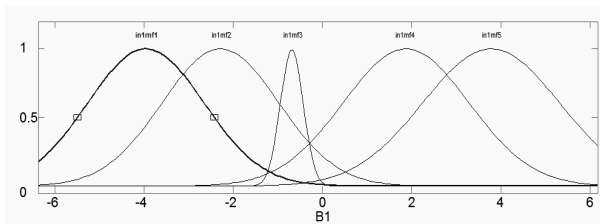

Fig. 6. Gaussian membership functions corresponding to the input B1

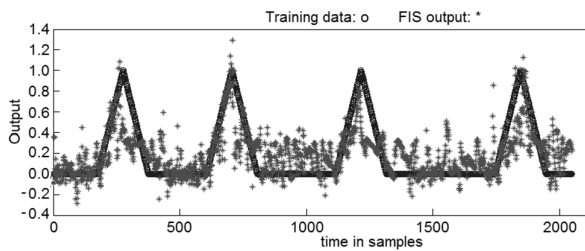

Fig. 7. ANFIS output and triangle pulses.

VI. RESULTS

The captured signals were analyzed using a time window of 16 seconds, with a sampling frequency of 128 samples per second. Figure 8 shows the 14 electrodes raw signals obtained from the emotive headset. As described before, a band-pass filtering stage is applied to the raw data. Figure 9 shows information from the electrodes T8, FC6, F4, F8 and AF4 signals, after the filter is applied.

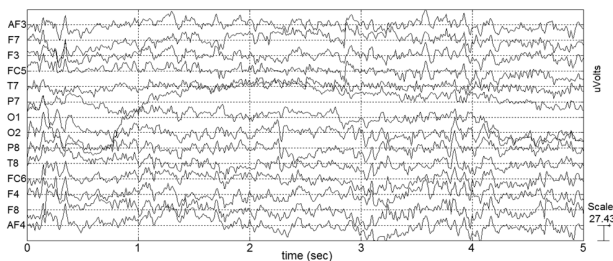

Fig. 8. Raw data from the EEG headset.

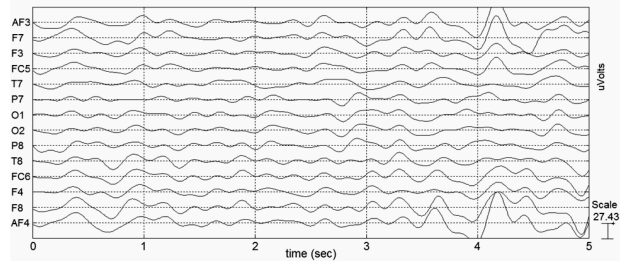

Fig. 9. Prefiltered EEG signals.

The P300 signals are predominant in the brain central area, thus the P300 is typically measured from the Pz, Cz, Fz electrodes. The Emotive headset does not include specific electrodes over the brain central area, however, the headset can be positioned in such a way that the electrodes AF3, AF4, F3, and F4, are able to collect the EEG signals relevant to the P300 experiment described in this work. The EEG signals obtained from the 14 electrodes are then processed through the ICA algorithm. The 14 channels are shown in Fig. 10. Typically, the P300 signals are embedded in artifacts, and they appear in two different channels; in this case channel 2 and 3. After the blind source separation applied to electrodes AF3, AF4, F3, and F4 signals, it can be noticed that P300 signals are visible on channel 2, while the others separated channels show some artifacts such as the myoelectric signal from blinking, which is predominant in AF3 and AF4 electrodes, cardiac rhythm, and system noise. The signals obtained after the ICA separation, are shown in Figure 11.

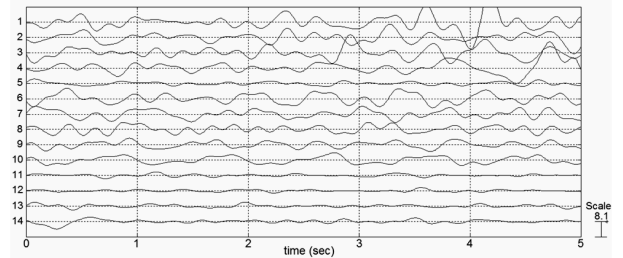

Fig. 10. 14 channels entered to the ICA algorithm.

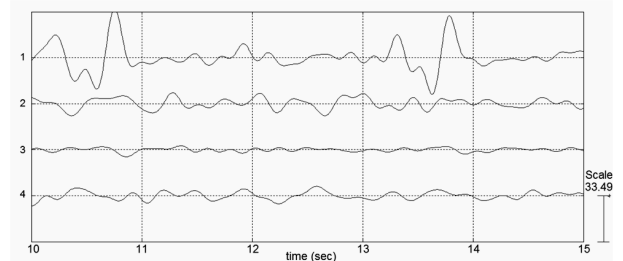

Fig. 11. Separated signals obtained from the ICA algorithm.

A time-scale analysis in the wavelet domain was then performed in order to locate the energy peaks corresponding to the P300 rhythm. DWT sub-band coding with 11 decomposition levels, using a Daubechies-4 wavelet was applied to channel 2, as shown in Fig. 12. It can be seen that the P300 peaks are easily distinguished in the wavelet domain. The energy peaks in the scalogram of Fig. 12, are located in the bands 0.5-1Hz and 1-2Hz, as expected. It was

noted that P300 rhythms were distinguished better in the EEG signals corresponding to the 8 first events in the experiment. After that time lapse, the experiment became tedious for most of the users, with the consequence of generating low-level P300 signals, undetectable in the experiments. Figure 13 shows a typical obtained signal, corresponding to the detection of P300 rhythms, as the output of the ANFIS system. Table II summarizes the total detection accuracy obtained with the proposed system.

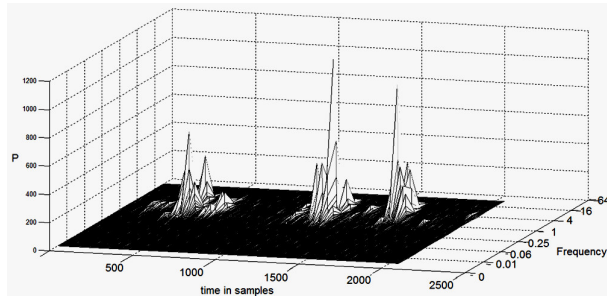

Fig. 12. Scalogram of signal from channel 2.

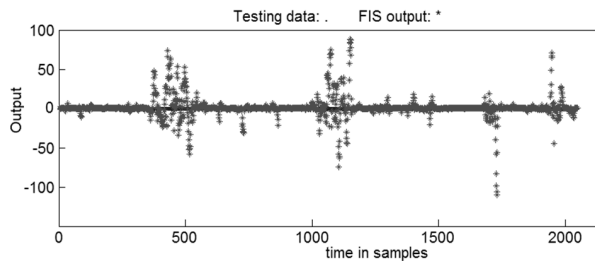

Fig. 13. ANFIS output showing detection of P-300 events

Table II. Results obtained on the P300 rhythm detection.

Detected	85%
Undetected	15%
Detected taking account false positive events	60%

## VII. CONCLUDING REMARKS

This paper presented an experiment on P300-rhythm detection based on ICA-based blind source separation, wavelet analysis, and an ANFIS model. The results presented in this paper are part of a project with the ultimate goal of designing and developing brain computer interface systems. These experiments support the feasibility to detect P300 events using the Emotiv headset, through an ANFIS approach, which can be used as information control for external devices in BCI applications. The proposed method is suitable for integration into a brain-computer interface, under a proper control paradigm. DWT coefficients could be used further as input to a variety of classifiers using different techniques, such as distance-based, k-nearest neighbor or Support Vector Machines (SVM).

## REFERENCES

- [1] Paul Sajda, Klaus R. Muller, Krishna V. Shenoy, "Brain Computer Interfaces", IEEE Signal Processing Magazine, No. 16, January, 2008.
- [2] Theodore W. Berger, John K. Chapin, Greg A. Gerhardt, Dennis J. McFarland, José C. Principe, Walid V. Soussou, Dawn M. Taylor, Patrick A. Tresco, "WTEC Panel Report on International Assessment of Research and Development in Brain-Computer Interfaces", World Technology Evaluation Center, Inc., 2007.
- [3] Bashashati, M. Fatourehchi, R. K. Ward, and G. E. Birch, "A survey of signal processing algorithms in brain-computer interfaces based on electrical brain signals," *Journal of Neural Engineering*, vol. 4, no. 2, pp. R32–R57, 2007.
- [4] Ying Gu, Omar Feix do Nascimento, Marie-Francoise Lucas, Dario Farina, "Identification of task parameters from movement-related cortical potentials", *Medical and Biological Engineering and Computing*, Vol. 47, pp. 1257–1264, 2009.
- [5] Audrey S Royer, Bin He, "Goal Selection vs. Process Control in a Brain-Computer Interface based on Sensorimotor Rhythms", *Journal of Neural Engineering* 6(1): 016005, February 2009.
- [6] Delaram Jarchi, Vahid Abolghasemi, Saeid Sanei, "Source localization of brain rhythms by empirical mode decomposition and spatial notch filtering", 17th European Signal Processing Conference (EUSIPCO 2009), Glasgow, Scotland, August 24-28, 2009
- [7] Kavitha P. Thomas, Cuntai Guan, Chiew Tong Lau, A. P. Vinod, Kai Keng Ang, "A new discriminative common spatial pattern method for motor imagery brain computer interfaces", *IEEE Transactions on Biomedical Engineering*, vol. 56, no. 11, november 2009.
- [8] Danhua Zhu, Jordi Bieger, Gary Garcia-Molina, Ronald M. Aarts, "A survey of stimulation methods used in SSVEP-based BCIs", *Computational Intelligence and Neuroscience*, Hindawi Publishing Corporation, 702357, March, 2010.
- [9] Christian Mandel, Thorsten Luth, Tim Laue, Thomas Rofer, Axel Graser, Bernd Krieg-Bruckner, "Navigating a smart wheelchair with a brain-computer interface interpreting steady-state visual evoked potentials", *Proceedings of the IEEE/RSJ International Conference On Intelligent Robots and Systems*, pp. 1118-1125, St. Louis, MO, 2009.
- [10] David E. Linden, "The P300: Where in the brain is it produced and what does it tell us?", *The Neuroscientist*, Vol. 11, No. 6, 563-576, 2005.
- [11] Bernardo dal Seno, Matteo Matteucci, Luca Mainardi, "Online Detection of P300 and Error Potentials in a BCI Speller", *Computational Intelligence and Neuroscience*, 307254, 2010.
- [12] Brice Rebsamen, Etienne Burdet, Cuntai Guan, Haihong Zhang, Chee Leong Teo, Qiang Zeng, Marcelo Ang, Christian Laugier, "A Brain-Controlled Wheelchair Based on P300 and Path Guidance", *Proceedings of IEEE/RAS-EMBS International Conference on Biomedical Robotics and Biomechanics*, 2006.
- [13] Kun Li, Ravi Sankar, Yael Arbel, Emanuel Donchin, "P300-based single trial Independent Component Analysis on EEG Signal", *Lecture Notes, Foundations of Augmented Cognition. Neuroergonomics and Operational Neuroscience*, Springer, pp. 404-410, 2009.
- [14] M.B. Priestley, "Wavelets and time-dependent spectral analysis", *Journal of Time Series Analysis*, Vol.17, No. 1, pp. 85 – 103, 2008.
- [15] Mark A. Pinsky, *Introduction to Fourier Analysis and Wavelets*, Graduate Studies in Mathematics, Vol. 102, American Mathematical Society, 2009.
- [16] Amar Kachenoura, Laurent Albera, Lotfi Senhadji, and Pierre Comon, "ICA: A Potential Tool for BCI Systems", *IEEE Signal Processing Magazine*, pp. 57-68, January 2008.
- [17] John L. Semmlow, *Biosignal and Medical Image Processing Second Edition*, CRC Press, Taylor and Francis Group, New York, 2008.
- [18] Emotiv Systems Inc. Researchers. <http://www.emotiv.com/researchers/>
- [19] Ernst Niedermeyer, Fernando Lopes da Silva, *Electroencephalography, Basic Principles, Clinical Applications, and Related Fields*, page 140, Lippincott Williams & Wilkins, 2004.
- [20] Douglas A. G. Vieira, Waldir M. Caminhas, Joao A. Vasconcelos, "Extracting sensitivity information of electromagnetic device models using a modified ANFIS topology", *IEEE Transactions on Magnetics*, Vol. 40, No. 2, March, 2004.
- [21] Fi-John Chang, Ya-Ting Chang, "Adaptive neuro-fuzzy inference system for prediction of water level in reservoir", *Advances in Water Resources*, Vol. 29, pp. 1–10, 2006.
- [22] Ahmet Baylar, Davut Hanbay, Enrah Ozpolat, "Modeling aeration efficiency of stepped cascades by using ANFIS", *Acta Hydrochimica et Hydrobiologica*, Vol. 35, No. 2, pp. 186 – 192, 2007.
- [23] Abdulhamit Subasi, "Application of adaptive neuro-fuzzy inference system for epileptic seizure detection using wavelet feature extraction", *Computers in Biology and Medicine*, Vol. 37, pp. 227–244, 2007.